

RHR Combined Room Temperature and Humidity Sensors (Controllers)

The RHR sensors are designed to detect relative humidity and temperature in the room spaces. The RHR sensors have linear 0..10V signals outputs relating to humidity and temperature. The RHRC sensors have 2 x 4..20mA outputs.

The RHR sensors provide high accuracy and offer 2%rH humidity measurement.

The RHR sensors can be installed on a wall surface or on a wall mounting box in dry indoor environment. The RHR sensors come with a number of options such as display, active/passive setpoint, digital output, occupancy detection, push button, lux level measurement and passive resistive sensor elements.

The RHR sensors can also operate as Temperature, Light Level or Humidity controllers.

The optional display can be used for local indication and alarming.



Model Type	Model	Description
	RHR	RHR Room Humidity and Temperature Sensor (Controller), 0..10Vdc Outputs
	RHRC	RHR Room Humidity and Temperature Sensor (Controller), 4..20mA Outputs
	-LCD	Display and Alarm Indication Option
	-DO	Digital Output Option (2DOs)
	-SP	Active Setpoint Option (for control loops) ^{Note 1,2}
	-SPR	Passive Setpoint Option (10kOhm potentiometer) ^{Note 1,2}
	-LL	Light Level Measurement and Occupancy Detection (with digital output) Option ^{Note 1}
	-PB	Push Button Option (with digital output)
	-TE-NTC10K3	Passive Temperature Sensor Option
Accessories	Model	Description
	SW-DCT-USB	Windows Device Configuration Tool Software with Serial USB Interface, 1.8m USB Lead

Note 1: If -SP/-SPR Option is selected the -LL options are no longer available (and vice versa).

Note 2: SP and SPR options cannot be fitted at the same time.

Order Codes

R H R (C)- LCD - SP- PB

e.g. RHR-LCD-SP-PB

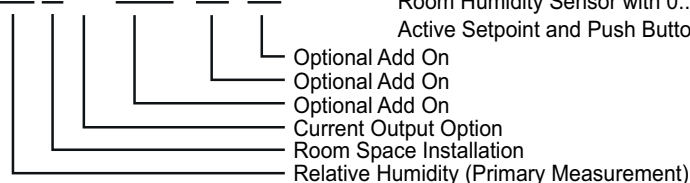
Room Humidity Sensor with 0..10Vdc Outputs,
Active Setpoint and Push Button

Technical Data

Power Supply	Power supply	24Vac/dc -10%/+15%, max 1VA
Displays and Interfaces	Option -LCD	LCD Display for Showing Humidity, Temperature, Light Level and Alarm Condition using Backlight (configurable through the tool)
	Option -SP	Active Setpoint Potentiometer Knob (for control setpoint; adjustable min/max limits)
	Option -SPR	Passive Setpoint Knob (10kOhm potentiometer for external equipment)
	Option -PB	Push Button; timed status available through DO1 or DO2
Signal Outputs	RHR Transmitters	3 x 0..10Vdc < 5mA; 100k min impedance for 1% accuracy
	RHRC Transmitters	2 x 4..20mA max 400 Ohms
	Option -DO	2 x 24Vac Triacs; 2A maximum; requires 24Vac Power Supply (DO1 & DO2)
	Option -PB	DO1 or DO2 configurable as 24Vac Triac; requires 24Vac Power Supply (PB option is supplied with DO1 & DO2 fitted)
	Option -OC	DO1 or DO2 configurable as 24Vac Triac; requires 24Vac Power Supply (OC option is supplied with DO1 & DO2 fitted)
	Option -SPR	0..10kOhm Resistance; Common 0V
	Option -TE-NTC10K3	NTC10K3 Thermistor; Common 0V
Sensing Characteristics	Humidity	
	Range	0..100%rH
	Accuracy	±2% rH (within 0..90% rh)
	Temperature	
	Range	0..50°C (32..122°F)
	Accuracy	±0.3°C @ 25°C
	Occupancy; Option -LL	
	Occupancy	Infrared Detection (Adjustable Delay)
	Light Level; Option -LL	
	Range	0..3,000 Lux
Passive Temperature; Option -TE-NTC10K3 (Other elements available on request)	Range	NTC10K3 Thermistor, 10kOhms @ 25°C
	Accuracy	±0.2°C
Connections	Terminal Connections	Solid and Stranded Cable; 55° Angle for Wiring Maximum Size: 0.05 to 1.5mm ² (EN ISO) / 14 to 30 AWG (UL) Rising Clamp: Size 2.5 x 1.9mm
Environmental Conditions	Operating	
	Temperature	0°C...+50°C (32..122°F)
	Humidity	0..95%rh (non-cond.)
	Storage	
Temperature	-30°C...+70°C (-22..158°F)	
Humidity	0..95%rh (non-cond.)	
Standards	CE Conformity	CE Directive 2004/108/EY EN61000-6-3: 2001 (Generic Emission) EN61000-6-1: 2001 (Generic Immunity).
	Degree of Protection	IP20
Housing	Housing Material	ABS Plastics, Self Extinguishing, RAL9010 Pure White
	Mounting	Wall or Junction Box Mounting
	Dimensions	W86 x H120 x D29mm

Weight 180g

Wiring Terminals

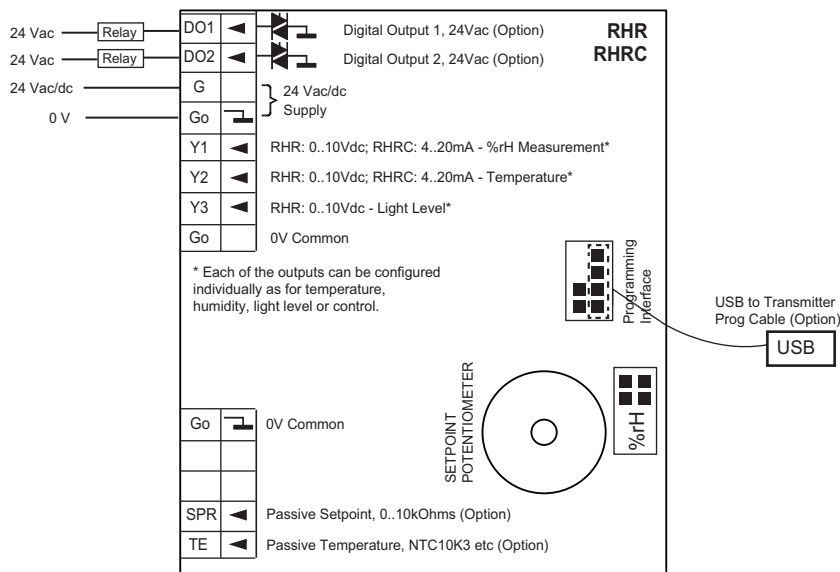

DO1	Digital Output; 24Vac Triac Switching to 0V; max. 2A (option)
DO2	Digital Output; 24Vac Triac Switching to 0V; max. 2A (option)
G	24Vac/dc Power Supply
G0	0V Common
Y1	RHR: 0..10Vdc Analogue Output (Function Selectable, default %rH) RHRC: 4..20mA (Function Selectable, default %rH)
Y2	RHR: 0..10Vdc Analogue Output (Function Selectable, default temp) RHRC: 4..20mA (Function Selectable, default temp)
Y3	RHR: 0..10Vdc Analogue Output (Function Selectable) RHRC: Not Available
G0	0V Common
G0	0V Common
N/A	Not applicable
N/A	Not applicable
SPR	Passive Setpoint, 0..10kOhms (option)
TE	Passive Temperature. NTC10K3 (option)

Wiring Precautions

Switch off the power before any wiring is carried out. If the sensor has the LCD display fitted, unplug the LCD display and then wire the power supply and analogue outputs, if relevant.

After the wiring has been completed; plug-in the display and power up the sensor.

Y1/Y2/Y3 Analogue Output Operation (Modes)

The analogue outputs Y1/Y2/Y3 can be configured for the following options.

Output Modes	Description
Temperature Measurement (Default for Y2)	The output represents the temperature measurement. This is scaled over 0..10V (RHR) or 4..20mA (RHRC).
Humidity Measurement (Default for Y1)	The output represents the humidity measurement. This is scaled over 0..10V (RHR) or 4..20mA (RHRC).
Light Measurement	The output represents the light level measurement. This is scaled over 0..10V (RHR) or 4..20mA (RHRC).
Temperature Control	The output represents the temperature control signal.
Humidity Control	The output represents the humidity control signal.
Light Control (LL-option required)	The output represents the light level (LUX) control signal.
Potentiometer	Allows the setpoint potentiometer position to be fed to the analogue output as 0..10V signal.

Note: RHRC transmitters have only Y1 and Y2 outputs.

DO1/DO2 Digital Output (Options)

When DO1/DO2 digital output option is fitted (-DO option); this can be used to switch plants on/off based on a configured measurement and setpoint (thermostatic operation). If OC (Occupancy Sensor) option is fitted and then selected, the DO1/DO2 is used to switch output on when occupancy is detected. If the push button option (-PB) is fitted then DO1/DO2 can be set to switch ON when push button is pressed (delayed switch off).

Digital Output Mode Options	Description (Typical Operation)
Temperature Control Mode (e.g. Low Temperature Limit)	Reverse Mode: The DO1/DO2 is switched ON when the temperature drops below the Temperature Setpoint - Temperature Mode Hysteresis. The output is switched OFF when the temperature exceeds the Setpoint. The control direction is adjustable; reverse (heating) / direct (cooling).
Humidity Control Mode (e.g. Humidity High Limit)	Direct Mode: The DO1/DO2 is switched ON when the humidity reading exceeds the Humidity Setpoint (60% default) + Humidity Digital Output Mode Hysteresis, and switches OFF when the humidity drops below the Setpoint. The control direction is adjustable; reverse (humidification) / direct (de-humidification).
Light Level Control (LUX) Mode (e.g. Low Light Level) (LL-option required)	Reverse Mode: The DO1/DO2 is switched ON when the light level drops below the Light Level Setpoint - Light Level Digital Output Mode Hysteresis, and switches OFF when the level increases above Setpoint. The control direction is adjustable.
Occupancy (LL-option required)	The DO1/DO2 is switched ON when the occupancy sensor detects occupancy; the output remains on adjustable time "Occupancy Delay Time Setting" plus approx 10 seconds after occupancy has been detected.
Push Button (PB-option required)	If -PB option is fitted, it is possible to have the DO1 (or DO2) on for the "Push Button Delay Time" specified in the settings after the pressing of button is detected.

Humidity Measurement Output Scaling and Single Point Calibration

The RHR measures the room space humidity. The humidity reading is available over any of the analogue outputs (Y1/Y2/Y3 for RHR, and Y1/Y2 for RHRC). This output is scaled as default 0% = 0°C and 100% = 100%rH. The scaling can be modified through Maximum Humidity Scaling parameter.

Furthermore the humidity measurement reading can be adjusted on site using the Single Point Calibration field.

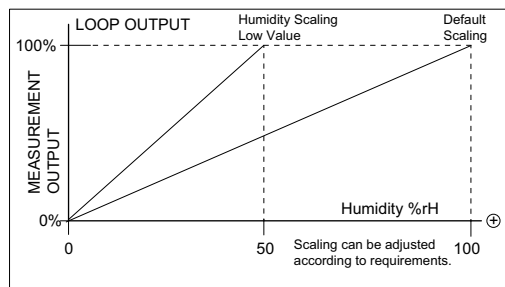

Temperature Measurement Output Scaling and Single Point Calibration

The RHR measures the room space temperature, and the measurement can be sent to any of the analogue outputs (Y1/Y2/Y3 for RHR, and Y1/Y2 for RHRC). This output is scaled as default 0% = 0°C and 100% = 50°C. The scaling can be modified through Maximum Temperature Scaling parameter. The output can also be scaled in Fahrenheit units.

Furthermore the temperature measurement reading can be adjusted on site using the Single Point Calibration field.

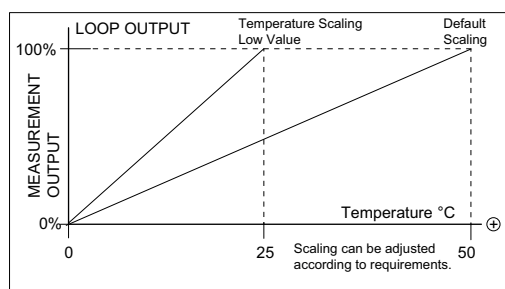

Light Level Measurement Output Scaling; Only when -LL Option Fitted

The RHR sensors fitted with -LL option measure the light level. The light level (LUX) measurement is available over any of the analogue outputs (Y1/Y2/Y3 for RHR, and Y1/Y2 for RHRC). This output is scaled as default 0% = 0 LUX and 100% = 3,000 LUX. The scaling can be modified through Maximum LUX Scaling parameter.

Furthermore the light level measurement reading can be adjusted on site using the Single Point Calibration field.

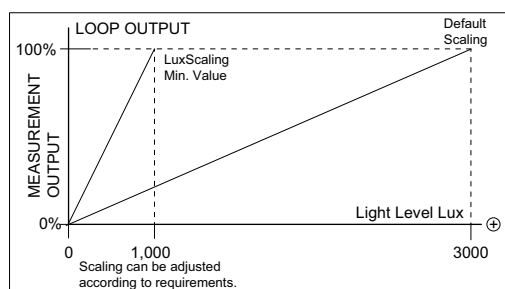

Occupancy Sensor (-LL Option)

The LL option offers a low power Passive Infrared Motion sensor with 21mm Fresnel lens designed for HVAC ventilation and lighting control applications. The sensor detects human body within its detection range. The LL sensor employs a dual element pyroelectric infrared sensor with advanced electronics circuitry.

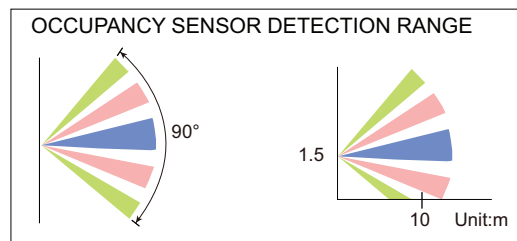

Humidity Control Loop Operation Mode Selection

Proportional or Proportional + Integral Control (Reverse/ Direct)

The humidity measurement can also be used for the humidity control. The calculated control demand is then send to the output Y1, Y2 or Y3 (depending on the corresponding analogue output mode selection).

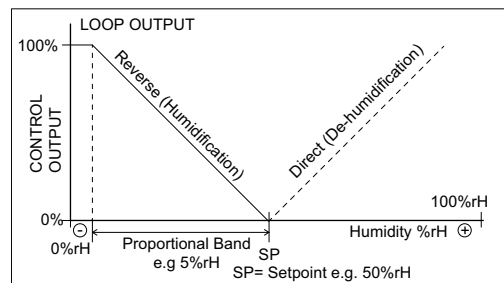

The humidity control loop output corresponds to the humidity setpoint and the humidity proportional band. If configured as Reverse Control (humidification), then if the humidity level drops below the setpoint the loop output starts to modulate to 100%.

When the humidity is the amount of the Proportional Band below the setpoint the loop output is 100%. In the Direct Control mode the output modulates in reverse. The configuration is done via the configuration parameters.

The humidity control loop can also be configured to operate as Proportional + Integral control by changing the Integral Action Time from 0 to a required value.

Boost Function

It is possible to boost/override the control output to 100%. This can be achieved via a push button on the device (PB-option). If the Push Button is used then the control output is boosted to 100% for the amount of Push Button Delay Time. When the boost is active the Blue Push Button backlight is lit.

Temperature Control Loop Operation

Proportional or PI Control (Reverse/ Direct)

The temperature measurement can also be used for the temperature control. The calculated control demand is then send to the output Y1, Y2 or Y3 (depending on the corresponding analogue output mode selection).

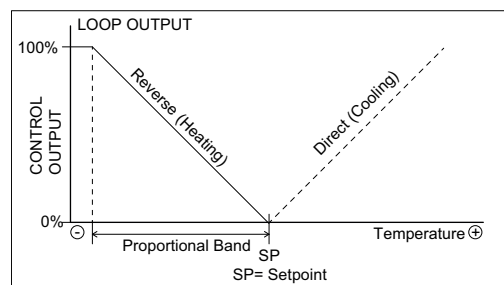

The temperature control loop output corresponds to the temperature setpoint and the temperature proportional band. If configured as Reverse Control (heating), then if the temperature level drops below the setpoint the loop output starts to modulate to 100%.

When the temperature is the amount of the Proportional Band below the setpoint the loop output is 100%. In the Direct Control mode the output modulates in reverse. The configuration is done via the configuration parameters.

The temperature control loop can also be configured to operate as Proportional + Integral control by changing the Integral Action Time from 0 to a required value.

Boost Function

It is possible to boost/override the control output to 100%. This can be achieved via a push button on the device (PB-option). If the Push Button is used then the control output is boosted to 100% for the amount of Push Button Delay Time. When the boost is active the Blue Push Button backlight is lit.

Light Level (LUX) Control Loop Operation; Only when -LL Option Fitted

Proportional Control (Reverse/ Direct)

The LUX measurement can also be used for the light control. The calculated control demand is sent to the output Y1, Y2 or Y3 (depending on the corresponding analogue output mode selection).

The light control loop output corresponds to the light level setpoint and the light control proportional band. If configured as Reverse Control, then if the light level drops below the setpoint the loop output starts to modulate to 100%. When the light level is the amount of the Proportional Band below the setpoint the loop output is 100%. In the Direct Control mode the output modulates in reverse. The configuration is done via the configuration parameters.

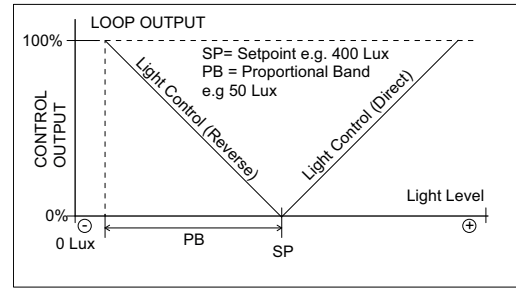

The LUX control loop can also be configured to operate as Proportional + Integral control by changing the Integral Action Time from 0 to a required value.

Unoccupied Setpoint

If the sensor has been configured for control, then it is possible to set the control setpoint to a different setting during the unoccupied periods (controlled by the occupancy sensor). Great feature for energy savings.

Maximum Control

Each of the analogue output can be configured as "Max Hum/Temp" in which case the maximum of humidity and temperature control loops is taken and sent to the analogue output.

Digital Output DO1/DO2 Control Modes (Optional)

When the digital outputs DO1 and DO2 are fitted they can be configured to work in any of the control modes; Temperature Control; Humidity Control or LUX control; the corresponding digital output is switched ON/OFF based on the corresponding Setpoint property and the corresponding hysteresis. The direction of the operation is also adjustable through Control Loop Operating Mode Parameter.

The diagram below illustrates the operation for Temperature Control Mode. The same concept is applicable for any of the DO1/DO2 control modes (Temperature, Humidity, LUX).

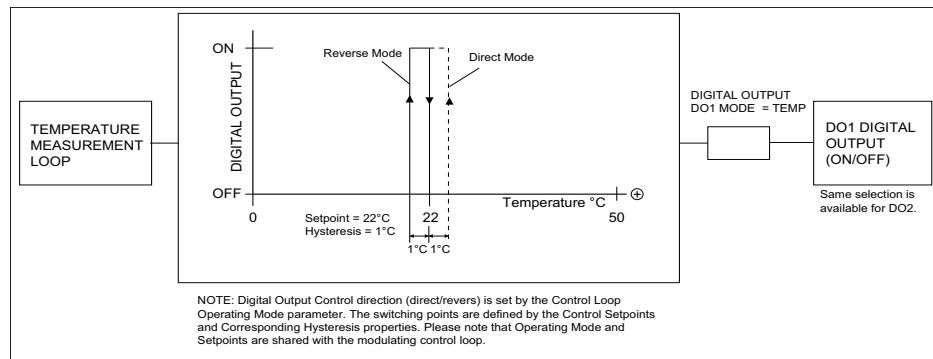

Active Setpoint Potentiometer Knob (-SP option)

With setpoint potentiometer (knob) option it is possible to adjust the current control setpoint. The adjustment shifts the temperature, humidity or LUX setpoint up or down depending on the configuration parameter settings up to the minimum and maximum value.

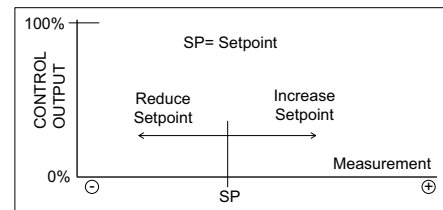

It is also possible to send the setpoint potentiometer position (-SP option) to an analogue output as 0..10V signal.

Display (Requires Option -LCD)

The LCD display shows the temperature, humidity and LUX readings. Temperature and LUX readings are displayed on the "top line". These readings can be rotated. The humidity reading is shown on the

"bottom line". The display has white backlight which is as default switched off. The backlight can be switched permanently on and its intensity can be adjusted via configuration tool.

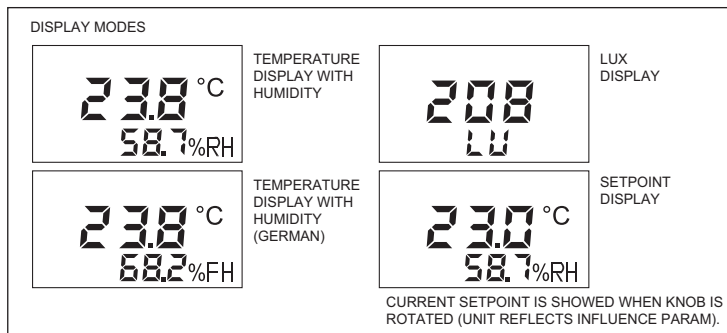

Note: The backlight is permanently on if activated. At 50% intensity the backlight lifetime is approx 10,000 hours. After this time the LCD module needs replacing if backlight is required. The display continues to operate without backlight.

Alarm Indication with -LCD Option

The sensor can be configured to monitor the humidity, temperature or light levels for alarms. The alarm condition is displayed using the backlight colours of the LCD. If the measurement exceeds the amber alarm limit then the amber backlight is switched ON. If the measurement exceeds the red alarm limit, the red backlight is switched ON. At normal condition no backlight is ON (can be configured to be white backlight in normal mode - note the maximum life of 10,000 hours of the backlight). The alarm mode has an adjustable hysteresis to prevent the backlight flickering and all alarm limits are adjustable.

Configuration Parameters and Programming

The parameter options can be configured using the SCT Sensor Configuration Tool software. The SCT Configuration software is connected via the PC USB cable (or via Bluetooth module) to the programming header of the transmitter as shown in the image below.

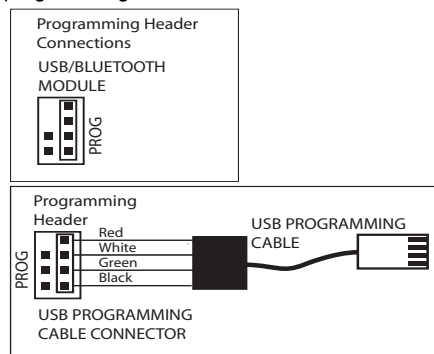

The correct process for connecting the sensor via the USB is as follows:-

- Disconnect USB Connector from PC
- Disconnect the Sensor from Power
- Plug-In the 4-Way Connector to the Sensor
- Connect the USB to the PC
- Power Up the Sensor

NOTE: Always disconnect USB from PC before plugging the cable into the sensor.

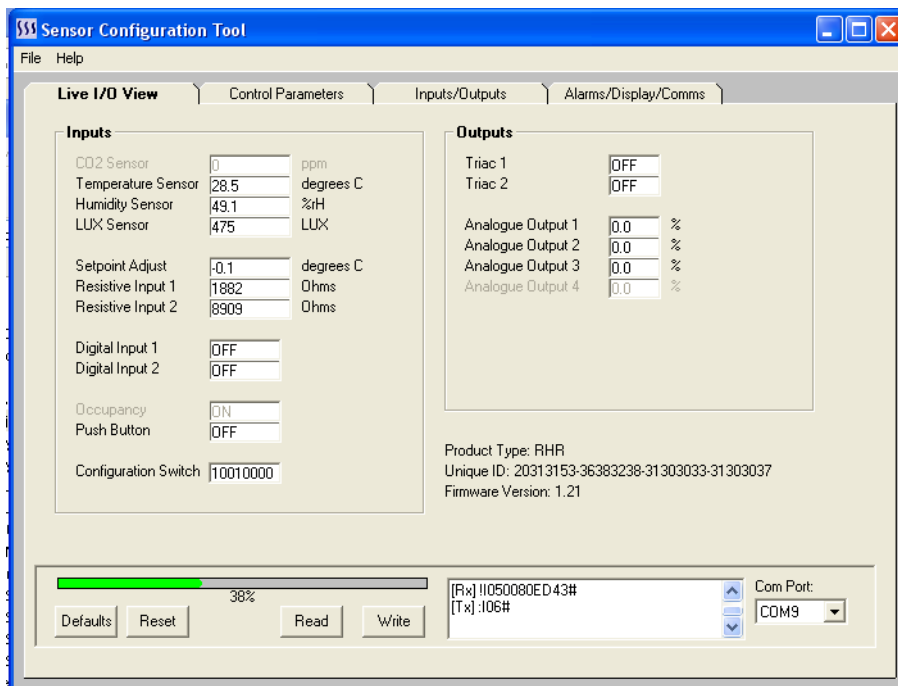

Common Parameters	
Parameter Name	Description
Defaults	Reloads the default configuration from the sensor non-volatile memory. Note: All modified settings are lost.
Reset	Performs soft reset of the sensor. Apply after major changes.
Read	Reads the sensor data.
Write	Writes the new settings to the sensor (automatically stored in the non-volatile memory)
COM Port	Select the COM port for the USB Cable or Bluetooth. USB cable driver must be installed in order the Serial to TTL connection to operate.

Live IO-View		
Parameter Name	Description	Range
INPUTS		
Temperature Sensor	Temperature Sensor Reading	0..50°C (32..122°F)
LUX Sensor	LUX Sensor Reading	0..3,000 LUX
Setpoint Adjust	Setpoint Adjuster Reading	-500..+500
Occupancy	Occupancy Status	Off - On
Push Button	Push Button Status	Off - On
Configuration Switch	Bit Switch Status for Each Switch	00000000 - 11111111
OUTPUTS		
Triac 1	Digital Output 1	Off - On
Triac 2	Digital Output 2	Off - On
Analogue Output 1	Analogue Output 1	0..100%
Analogue Output 2	Analogue Output 2	0..100%
Analogue Output 3	Analogue Output 3	0..100%

Control Parameters		
Parameter Name	Description	Range
TEMPERATURE		
Temperature Loop Operating Mode	Direction of the temperature control loop.	0 = Reverse Control (Heating) 1 = Direct Control (Cooling)
Temperature Control Setpoint	Temperature Setpoint	0.0...150.0°C/°F (Default 20°C)
Temperature Proportional Band	Temperature Proportional Band	1.0...150.0°C/°F (Default 50°C)

Control Parameters		
Parameter Name	Description	Range
Temperature Control Integral Action	Integral Action time of the temperature control loop. Set to 0 to disable.	0..10,000 seconds (Default 0s)
Temperature Digital Output Mode Hysteresis	Hysteresis for the digital output temperature control function.	0.1...150.0°C/°F (Default 2°C)
Temperature Loop Boost Input	Boosts the Control Output to 100%	Select Push Button 1 or 2

HUMIDITY

Humidity Loop Operating Mode	Direction of the humidity control loop.	0 = Reverse Control (Humidification) 1 = Direct Control (De-humidification)
Humidity Control Setpoint	Humidity Setpoint	0.0...100.0 %rH (Default 50%)
Humidity Proportional Band	Humidity Proportional Band	0.1...100.0 %rH (Default 20.0%)
Humidity Control Integral Action	Integral Action time of the humidity control loop. Set to 0 to disable.	0..10,000 seconds (Default 0s)
Humidity Digital Output Mode Hysteresis	Hysteresis for the digital output humidity control function.	0.1...100.0 %rH (Default 5.0%)
Humidity Loop Boost Input	Boosts the Control Output to 100%	Select Push Button 1 or 2

CO2 (Not Applicable)**LUX**

Lux Loop Operating Mode	Direction of the LUX control loop.	0 = Reverse Control 1 = Direct Control
Lux Control Setpoint	LUX Setpoint	0..3,000 Lux (Default 400 Lux)
LUX Proportional Band	LUX Proportional Band	1..3,000 Lux (Default 400 Lux)
LUX Control Integral Action	Integral Action time of the LUX control loop. Set to 0 to disable.	0..10,000 seconds (Default 0s)
LUX Digital Output Mode Hysteresis	Hysteresis for the digital output LUX control function.	1..3,000 Lux (Default 100 Lux)
LUX Loop Boost Input	Boosts the Control Output to 100%	Select Push Button 1 or 2

SETPOINT ADJUST

Setpoint Adjuster Minimum Value	Sets the minimum value for the setpoint (setpoint turned fully anti clockwise)	-500..0 (Default -3.0)
Setpoint Adjuster Maximum Value	Sets the maximum value for the setpoint (setpoint turned fully clockwise)	0..500 (Default 3.0)
Setpoint Value Influence to Control Setpoint	Setpoint Value Influence to Control Setpoint	0 = No Influence 1 = CO2 Control (Not Applicable) 2 = Temperature 3 = Humidity 4 = Lux
Unoccupied SPA	Changes the control setpoint to the set value when the space is unoccupied (requires -LL option)	0..500 (Default 0.0)

Inputs / Outputs

Parameter Name	Description	Range
SENSOR INPUTS		
Temperature Offset	One Point Temperature Calibration Field	-3.0..+3.0°C/°K (Default 0°C)
Temperature AO Scale	Analogue Output Maximum Temperature Scaling	0.1...150.0°C/°F (Default 50°C)
Humidity Offset	One Point Humidity Calibration Field	-5.0..+5.0 %rH (Default 0 %rH)
Humidity AO Scale	Analogue Output Humidity Maximum Scaling	0.1...100.0 %rH (Default 100.0%)
LUX AO Scale	Analogue Output Maximum Lux Scaling	1000..3,000 Lux (Default 3,000 Lux)
Occupancy Off Delay	Delay Time Setting for Occupancy	1..7200 Seconds (Default 600s)
Push Button Off Delay	Delay Time Setting for Push Button	1..7200 Seconds (Default 600s)

OUTPUTS

Inputs / Outputs		
Parameter Name	Description	Range
AO1 (Y1)	Analogue Output Y1 Mode	0 = Network (Not applicable) 1 = CO2 (Not applicable) 2 = Temperature Measurement 3 = Humidity Measurement 4 = Light Measurement (LUX) 5 = CO2 Control (Not Applicable) 6 = Temperature Control 7 = Humidity Control 8 = Light Control (LUX) 9 = Maximum (Not Applicable) 10 = Potentiometer 11 = Max Hum/Temp Control 12 = Max Hum/Temp/CO2 (N/A)
AO2 (Y2)	Analogue Output Y2 Mode	0 = Network (Not applicable) 1 = CO2 (Not applicable) 2 = Temperature Measurement 3 = Humidity Measurement 4 = Light Measurement (LUX) 5 = CO2 Control (Not Applicable) 6 = Temperature Control 7 = Humidity Control 8 = Light Control (LUX) 9 = Maximum (Not Applicable) 10 = Potentiometer 11 = Max Hum/Temp Control 12 = Max Hum/Temp/CO2 (N/A)
AO3 (Y3) Note: Not available with RHRC.	Analogue Output Y3 Mode	0 = Network (Not applicable) 1 = CO2 (Not applicable) 2 = Temperature Measurement 3 = Humidity Measurement 4 = Light Measurement (LUX) 5 = CO2 Control (Not Applicable) 6 = Temperature Control 7 = Humidity Control 8 = Light Control (LUX) 9 = Maximum (Not Applicable) 10 = Potentiometer 11 = Max Hum/Temp Control 12 = Max Hum/Temp/CO2 (N/A)
DO1	Digital Output 1 Mode	0 = Network (Not applicable) 1 = CO2 Relay (Not applicable) 2 = Temperature Relay 3 = Humidity Relay 4 = Light Relay (LUX) 5 = Occupancy Relay 6 = Push Button
DO2	Digital Output 2 Mode	0 = Network Value (N/A) 1 = CO2 Relay (N/A) 2 = Temperature Relay 3 = Humidity Relay 4 = Light Relay (LUX) 5 = Occupancy Relay 6 = Push Button

Alarm/Display/Comms		
Parameter Name	Description	Range
ALARMS		
Alarm Source	Alarm LED Mode	0 = Not Applicable (CO2) 1 = Temperature 2 = Humidity 3 = LUX
Alarm Amber Threshold	Amber Alarm LED Switching Point	0..5000 (Default 750)
Alarm Red Threshold	Red Alarm LED Switching Point	0..5000 (Default 1250)
Alarm Hysteresis	Alarm LED Hysteresis	0..5000 (Default 50)
DISPLAY		
Temperature Units	Temperature Unit Selection	0 = Celsius 1 = Fahrenheit

Alarm/Display/Comms		
Parameter Name	Description	Range
Language	Language Selection (for display rH vs FH)	0 = English (default) 1 = German
Display Mode	Display Mode	0 = Rotate Installed 1 = CO2 (Not applicable) 2 = Temperature Only 3 = LUX Only 4 = Setpoint Only
LCD brightness	Brightness of the LCD	Off - 10% to 100%

Parameter Storage The configuration parameters are stored in the non-volatile memory. The SCT (Sensor Configuration Tool) software will automatically store the register values on the non-volatile permanent memory after the changes are carried out.

Dimensions

